

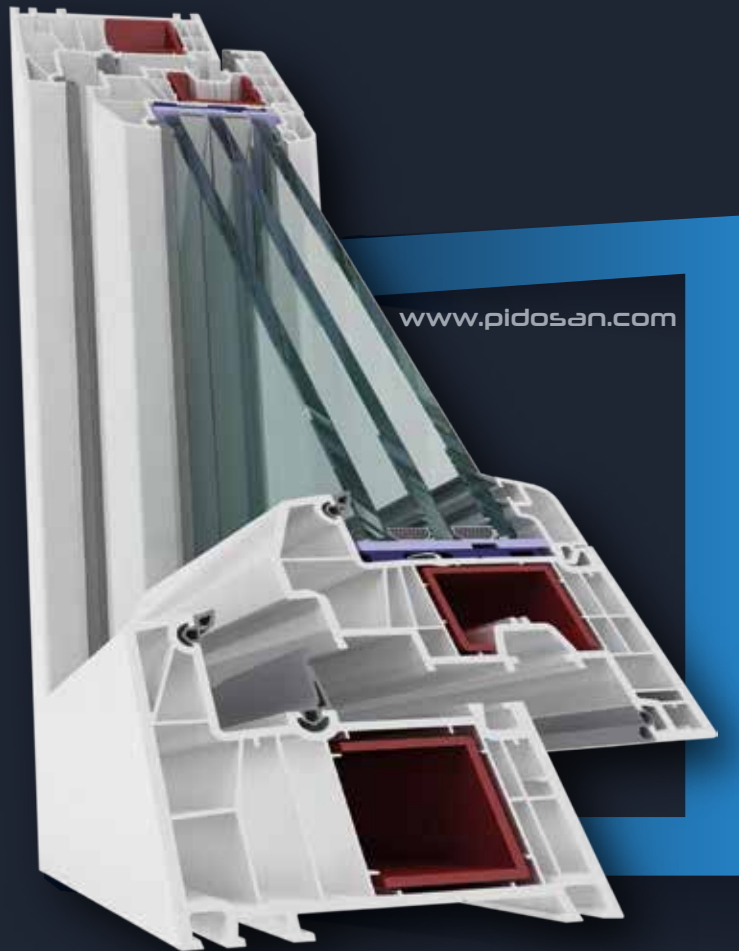

Pidosan[®]

KAPI - PENCERE



ECOLOGY
CONCEPT

2022

KALİTE / QUALITY

Çevreye duyarlı, müşteri beklentilerini karşılayan, ulusal ve uluslar arası yasal gereklilere uygun standartlardaki ürünlerini zamanında teslim etmeyi ilke edinen Pidosan kalite ve verimliliği her aşamada artırmak ve kendisini sürekli iyileştirmek için ;

- Tüm faaliyetlerinde müşteri tarafından tanımlanan kaliteyi kendi kalite hedefleri ile birleştirip uygulayarak,
- Sektörde tecrübeli personeline kalite bilincini yayarak,
- Personelin daha fazla sorumluluk üstlenmesini ve her aşamada katılımını sağlayarak,
- Sektördeki yeni teknolojiler ve yeni ürünleri takip ederek üretim altyapısı ve ürün gamını geliştirerek,
- Liderlik anlayışı ile bütün faaliyetlerinde müşteri ve çalışan bağlılığını sürdürmeyi prensip edinmiştir.

Pidosan bu temeller üzerine kurduğu kalite politikası ile sürekli olarak kendini yenileyen bir firma olmayı hedeflemektedir.



Pidosan PLASTIC AND TRADE INC. that is environmentally sensitive, satisfying the customer expectations, having the principle to deliver the goods in due time with standards in conform to national and international legal requirements; in order to improve the quality and productivity at every stage and continually improve ourselves;

- By applying own quality objectives combined with quality defined by the customers in all its activities,
- By spreading quality consciousness to own experinced personnel within the sector,
- By obtaining the undertake of more responsibility of the personnel and participation of them at every stage,

By developing production infrastructure and product range following the new technologies and new products in the sector,

- Makes the principle of carrying on customer and employee loyalty within its all activities with leadership understanding.

Pidosan PLASTIC AND TRADE INC. intents to be the company that renew itself continually together with its established quality policy based over this fundamentals.



1993 yılında kurulan ve kısa sürede Türkiye'nin PVC kapı-pencere sektöründe öncü kuruluşu konumunu kazanan Pidosan; markasına duyulan güven ve kalitesinden aldığı güçle PVC kapı - pencere ve tüm PVC sistemleri imalatı alanlarında hizmet vermektedir.

Pidosan grubu olarak 2016 yılı itibari ile, Ankara 1. Organize Sanayi Bölgesinde 20.000 m2 kapalı alan üzerine kurulu son teknoloji ile donatılmış olan fabrikamızda, üretimin başından sonuna büyük bir titizlikle kalite standartlarına uygun, insan sağlığı ön planda tutularak PVC profil üretimine başlamış bulunmaktayız. Yıllık 10.000 ton üretim kapasitesi ile PVC profil sektöründe, yurt içi ve yurt dışı pazarlarda varlığını her geçen gün artırmaktadır.

PVC kapı ve pencere üretimlerimiz; İvedik Organize Sanayi Bölgesinde 42 000 m2, Sincan Organize Sanayi Bölgesinde 20.000 m2 olmak üzere, toplamda 62.000 m2 kapalı alana sahip fabrikalarımızda günde 1200 adet doğrama olmak üzere yapılmaktadır.

Grubumuz; alanında uzman 500 daimi personel istihdam etmekte, 200'e yakın bayisi ile Ankara'nın tüm semt-ilçelerinde hizmet vermekte ve bunun yanında Türkiye'nin bir çok iline ve yurtdışı pazarlara da kusursuz olarak hizmet götürmekteyiz.

Üretim tesislerimiz, günümüz teknolojisi ile modernize tam otomatik makineler kullanılarak, her türlü talebe cevap verebilecek şekilde dizayn edilmiştir. Pidosan grubu; genç ve dinamik personelinin azimli çalışmalarıyla sektöründe "en iyi hizmet - en kaliteli ürün" amacıyla Ülkemizde PVC pencere üretimi sıralamasında büyük başarılarla imza atmıştır.

Pidosan markası, sahip olduğu geniş bayii ağı ve uzman kadrolarıyla verdiği hizmetler sayesinde müşterilerin kolaylıkla ürünlerine ulaşmasını sağlamaktadır. Vizyonumuz; "Çözüm Merkezi" sloganı ile sektördeki liderliğimizi koruyarak Ülkemizdeki marka bilinirliğini uluslararası pazarlara taşımaktır. Misyonumuz yaşam alanlarında güvenilir, yenilikçi ve konforlu çözümler sunmaktır. Bunlar için sahip olduğumuz temel değerlerimiz ise "dürüstlük, yetkinlik, sürekli gelişim, sorumluluk, katılımcılık, müşteri odaklılık, değerlere saygı, takdir, sürat"tir.

Pidosan grubu olarak mükemmelliğe olan tutkumuz, müşterilerimizden aldığımız güçle beraber üretmeye, araştırmaya, yeni tasarımlara, istihdam oluşturmaya ve Ülkemiz ekonomisine katkıda bulunmaya devam edeceğiz.

Pidosan Yönetim Kurulu

Pidosan was established in Ankara in 1993 has become a leader of manufacturing of PVC Door&Window systems keeps on investments in the production of PVC door&window systems encouraged by customers' reliance on Pidosan brand and quality.

As Pidosan, PVC extrusion factory which is equipped with the latest technology having 20.000 sqm indoor area in Ankara 1st Organized Industrial Zone have started to produce PVC Profile from beginning to end with the sense of production&quality standards keeping human health at the forefront as of 2016. With annual PVC profile production capacity of 10.000 tons, Pidosan has started to show its ambition and eager to increase our presence in PVC Profile market with its domestic and international customers.

Our PVC Door&Window systems have been produced in two factories which are established 42.000 sqm indoor area in İvedik Organized Industrial Zone and 20.000 sqm indoor area in Ankara 1st Organized Industrial Zone as 1200 doors and windows daily.

Pidosan Group's 500 permanent employee and approximately 200 sales points serve for all districts and counties of Ankara, several other cities and also foreign markets with perfect and precise approach.

Our production facilities are designed to meet all kinds of demands by using modernized fully automatic machines with today's technology. Pidosan group; has achieved great success in the production of PVC windows in our country with the aim of "best service - best quality product" in the sector with the determination of its young and dynamic staff.

Pidosan brand provides easy access to the products with the help of its extensive dealer network and qualified staff to its customers. With the motto of "Solution Center"; our vision is "by strengthening our leadership in the sector turning our national brand awareness into international markets". Our mission is "to provide reliable, innovative and comfortable solutions in living spaces". Our fundamental principles are "honesty, competence, continuous development, responsibility, participation, customer focus, respect for values, appreciation, speed".

With the passion for excellence and the power which is coming from customer satisfaction, as Pidosan, we will continue to produce, to research, to design and to contribute create employment and national economy.

Pidosan Board of Directors



24-32-44 mm
Uygulanabilir cam
kalınlıkları



Estetik görümlü
çift/üçlü cam çitası



Isı, ses, toz ve suyu
absorbe eden özel conta

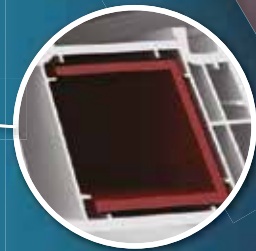

Destek Sacı

$U_f =$
0,90
W/m²K



3.Conta

82MM
6 ODACIK
CHAMBERS

Sađlam, Yüksek
Performanslı
(Isı, ses ve güvenlik),
Estetik yeni nesil
Pencere Sistemleri.

 **Pidosan**[®]
KAPI - PENCERE

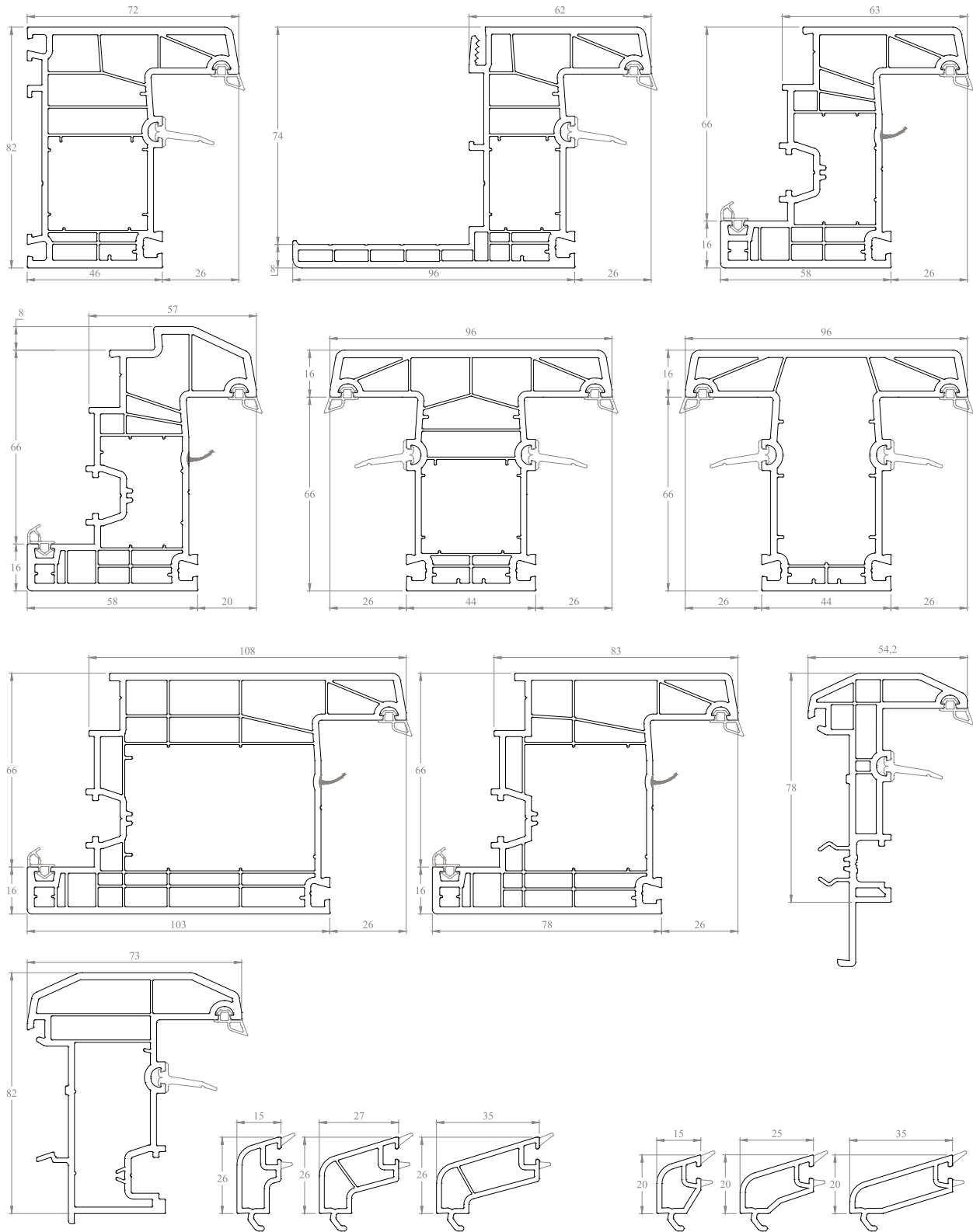



$U_f =$
1,3
W/m²K



4-20-24-30-34 mm
Uygulanabilir cam
kalınlıkları



Estetik görümlü
tek/çift/üçlü cam
çitası



Isı, ses, toz ve suyu
absorbe eden özel conta



Destek Sacı

70MM
5 ODACIK
CHAMBERS



Geleneksel
Pencere de,
Optimum
Çözümler

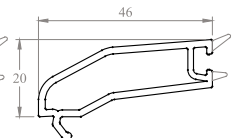
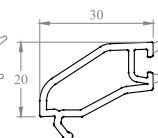
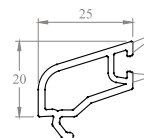
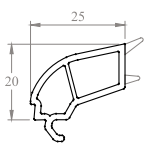
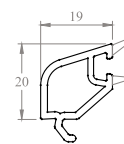
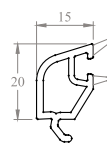
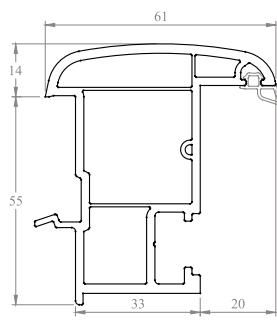
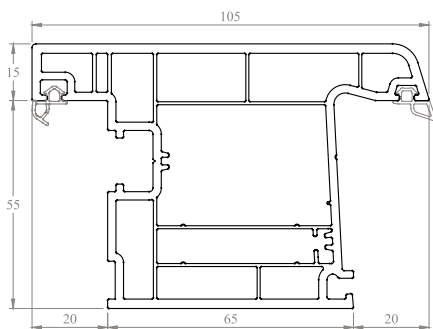
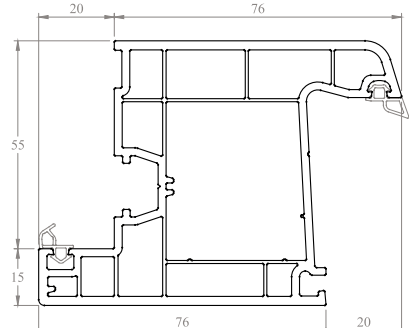
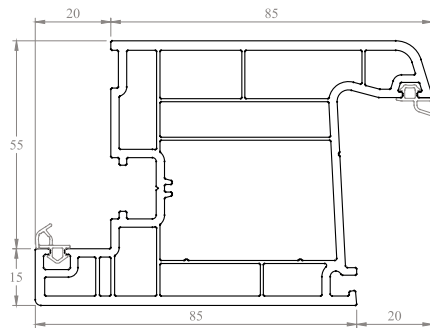
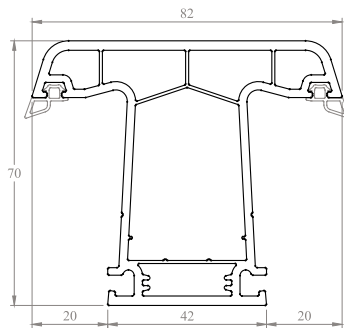
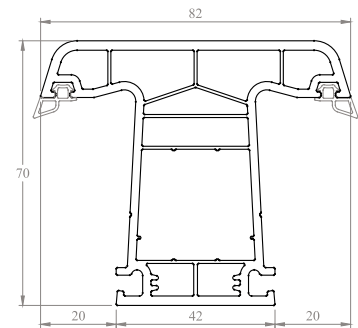
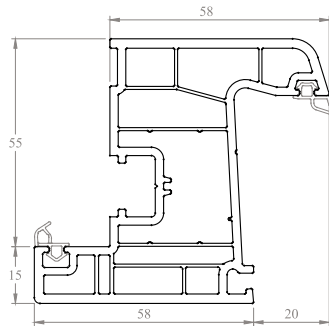
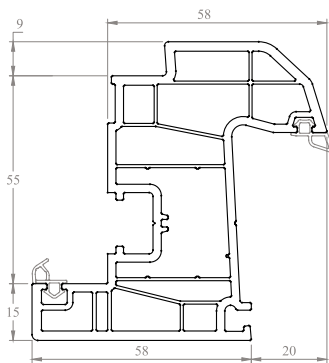
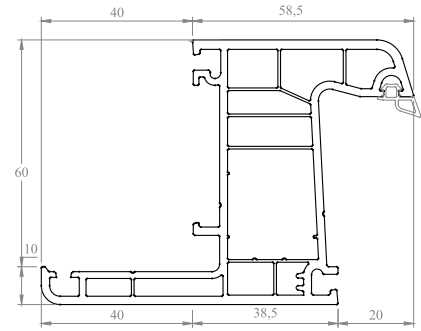
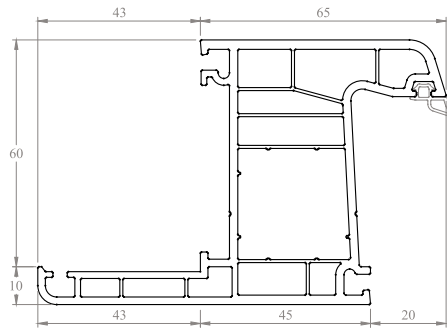
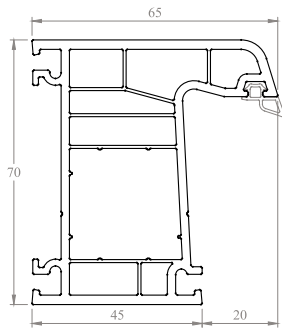



ECOLOGY
CONCEPT

$U_f = 1,4$
W/m²K



4-20-24 mm
Uygulanabilir cam
kalınlıkları



Estetik görünlü
tek/çift cam çitası



Isı, ses, toz ve suyu
absorbe eden özel conta



Destek sacı

60MM
4ODACIK
CHAMBERS



Yenilikçi
Yüzü ile
Ekonomik
Çözümler

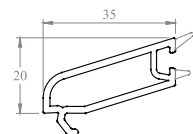
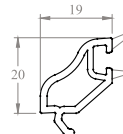
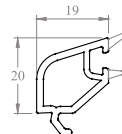
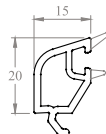
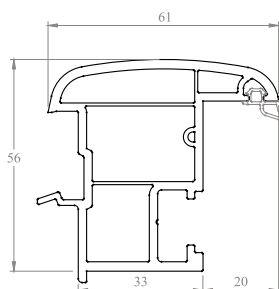
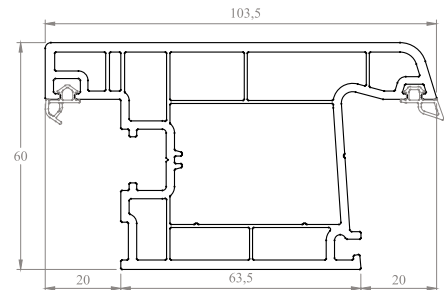
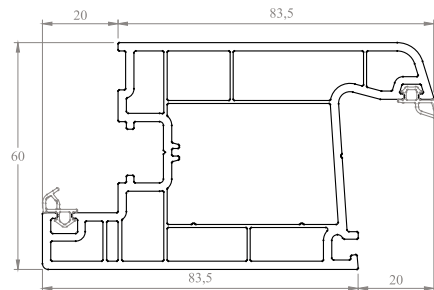
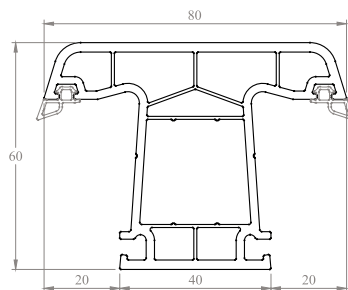
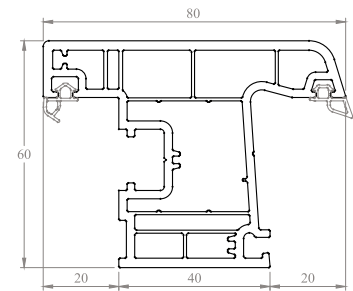
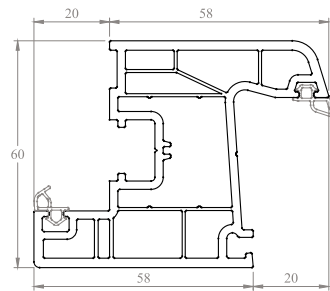
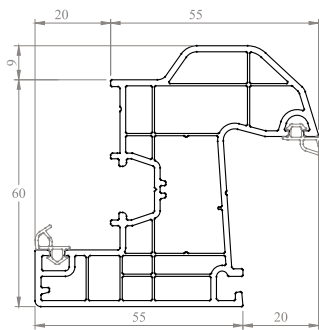
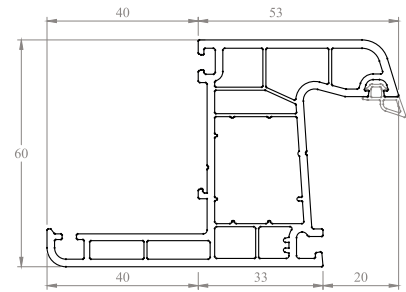
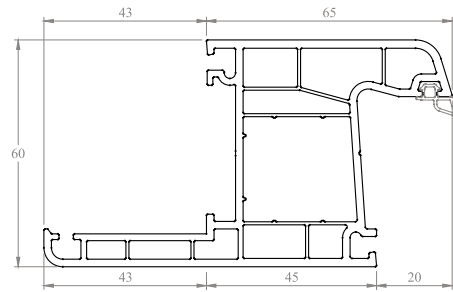
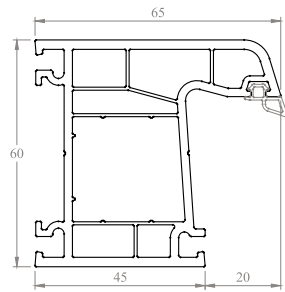



ECOLOGY
CONCEPT



4-20-24 mm
Uygulanabilir cam
kalınlıkları



Estetik görünlü
tek/çift cam çitası



Isı, ses, toz ve suyu
absorbe eden özel conta



Destek sacı

60MM
3 ODACIK
CHAMBERS



U_f
1,5
W/m²K

eco | 60 mm

Ekolojik
Ürün



 **Pidosan**[®]
KAPI - PENCERE

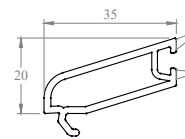
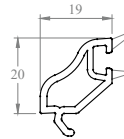
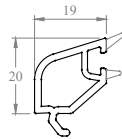
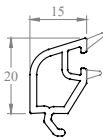
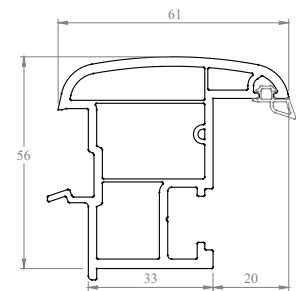
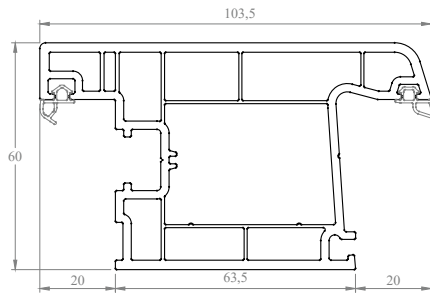
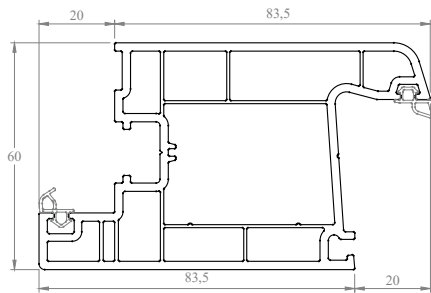
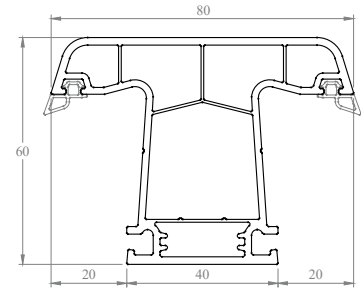
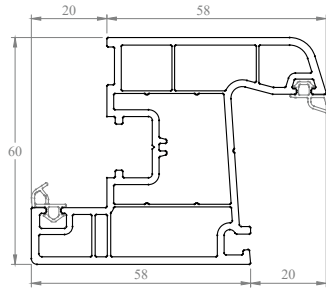
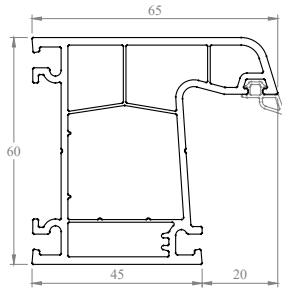



24-32-44 mm
Uygulanabilir cam
kalınlıkları



Estetik görümlü
çift/üçlü cam çitası



Isı, ses, toz ve suyu
absorbe eden özel conta



Destek Sacı



$U_f =$
0,90
W/m²K

82MM
5ODACIK
CHAMBERS

177MM
5ODACIK
CHAMBERS

Mükemmel tasarım
ve estetiđi sayesinde
mekanlarınızın
tarzına ferahlık
katar. Kolayca uyum
sađlar.



 **Pidosan**[®]
KAPI - PENCERE

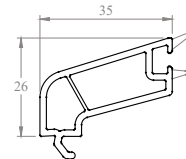
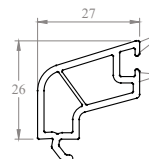
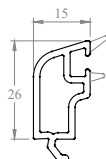
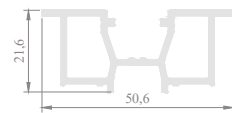
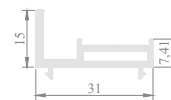
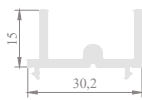
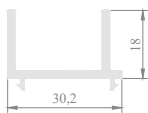
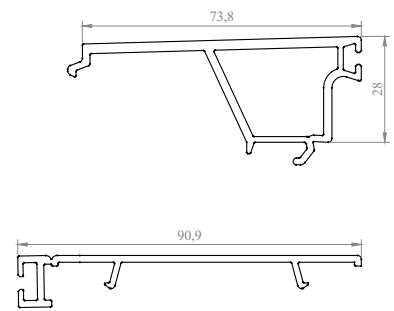
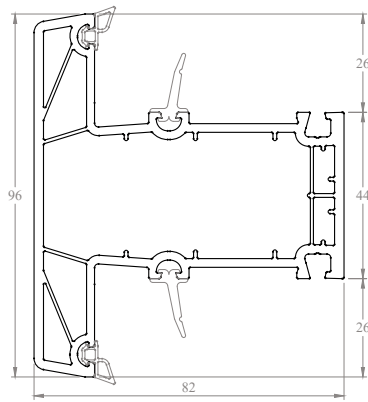
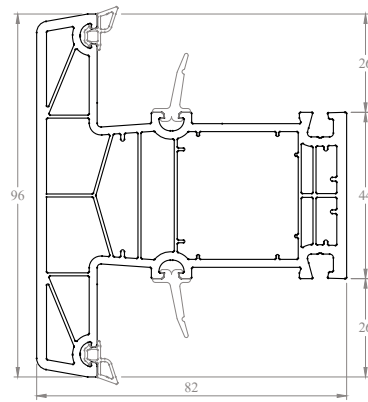
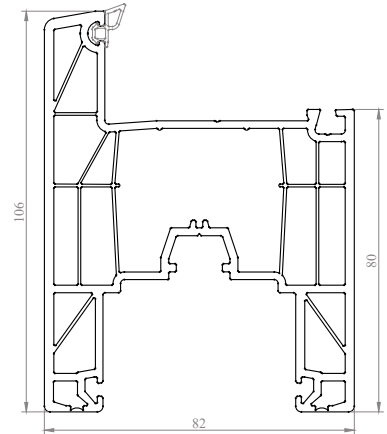
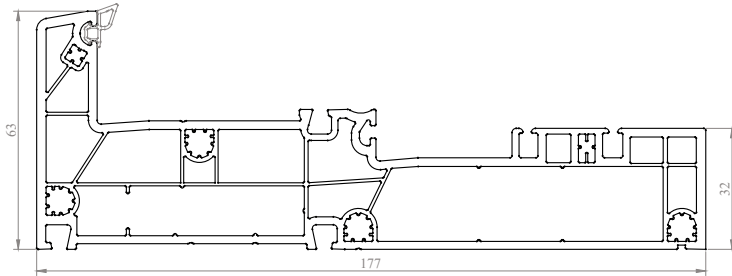



4-20 mm
Uygulanabilir cam
kalınlıkları



Estetik görümlü
tek/çift cam çitası



Isı, ses, toz ve suyu
absorbe eden özel conta



Destek sacı



50MM
3 ODACIK
CHAMBERS

70MM
3 ODACIK
CHAMBERS

Daha iyi
görünüm ve
geniş alanlar
için ekonomik
sürme çözümleri



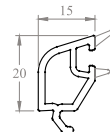
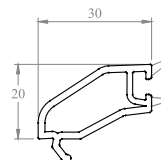
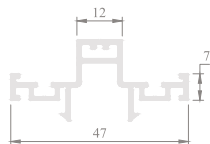
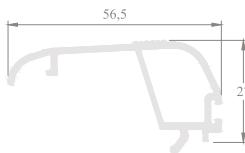
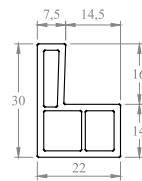
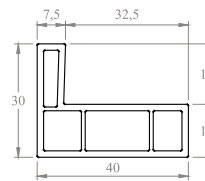
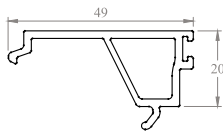
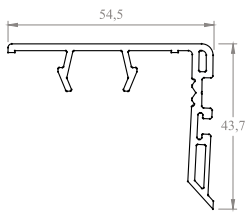
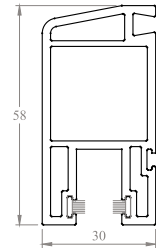
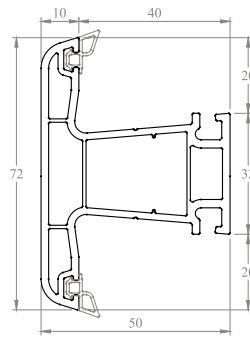
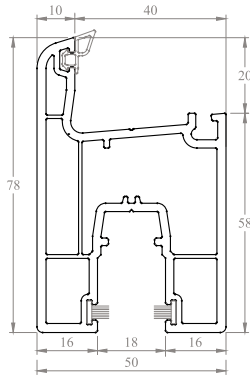
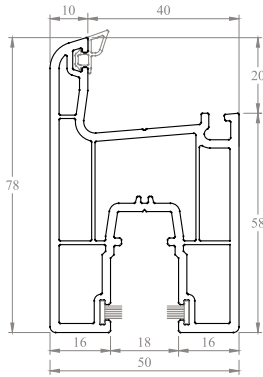
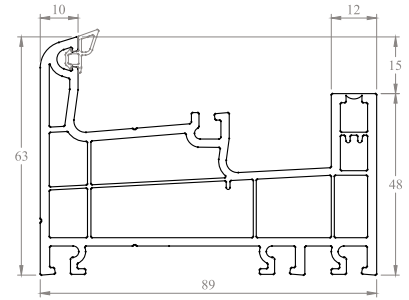
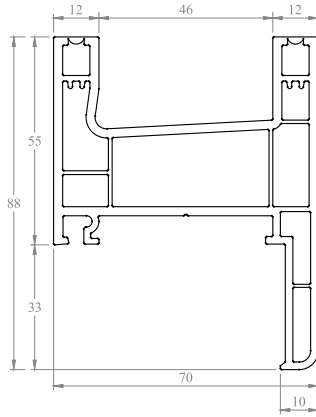
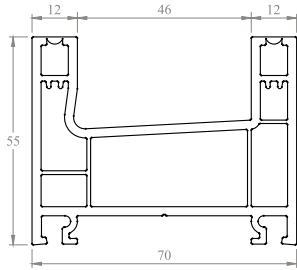



24-32-42 mm
Uygulanabilir cam
kalınlıkları



Estetik görümlü
çift/üçlü cam çitası



Isı, ses, toz ve suyu
absorbe eden özel conta



ECOLOGY
CONCEPT



Destek sacı



80mm
KANAT
SASH

185mm
KASA
FRAME



- Uygulama alanında en az 20 cm duvar kalınlığına ihtiyaç vardır.
- Bir kanat için taşıma kapasitesi 300 kg olup, yatay 3000 mm, dikey 2765 mm ye kadar kanat yapılabilir.
- Özel tasarlanmış taşıyıcı araba sayesinde son derece sessiz ve kolay çalışır ve istenilen noktada kanat sabitlenebilir.
- 4 kanatlı bir sistemde 12000 mm kadar genişlikteki alanlarda uygulanabilir.

Hebeschiebe

Daha Geniř,
Daha Ferah
Manzara
isteyenlere

 **Pidosan**[®]
KAPI - PENCERE



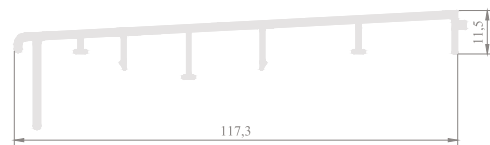
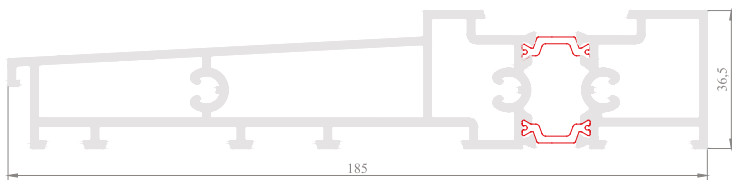
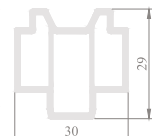
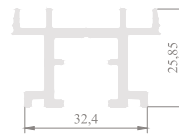
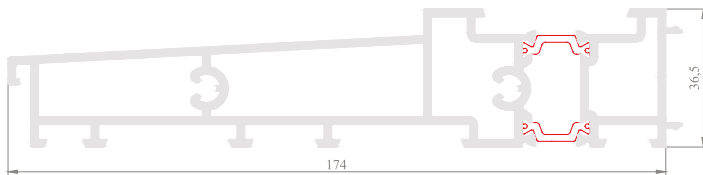
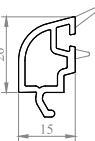
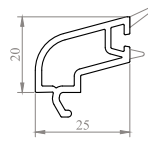
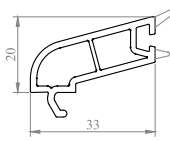
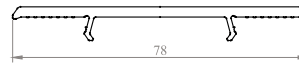
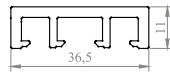
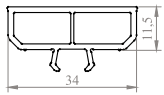
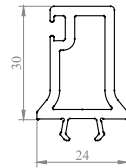
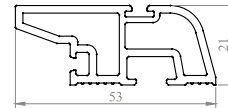
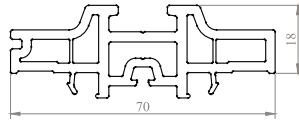
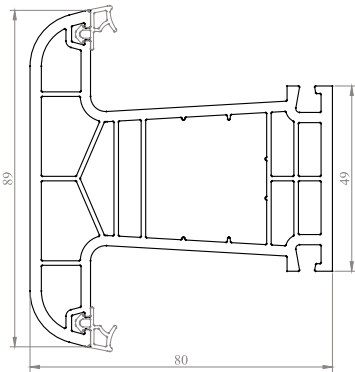
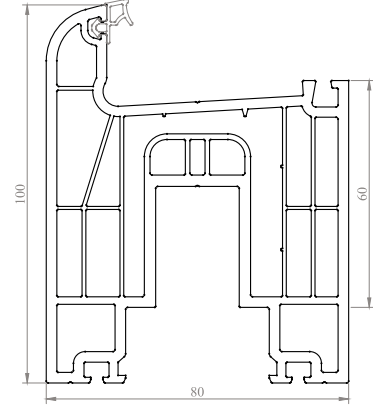
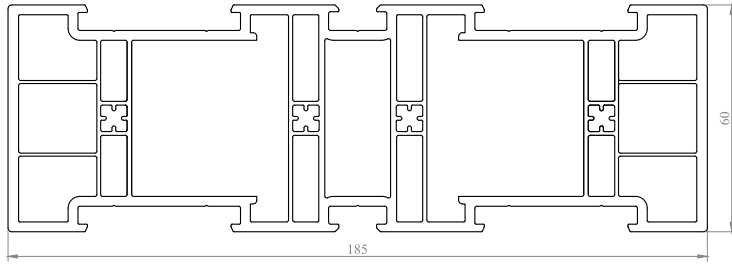



YARDIMCI PROFİLLER

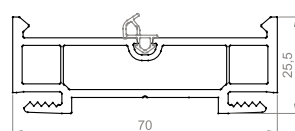
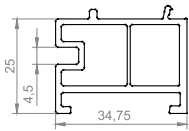
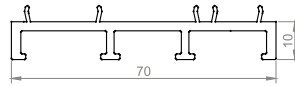
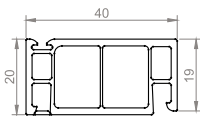
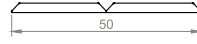
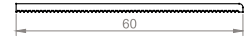
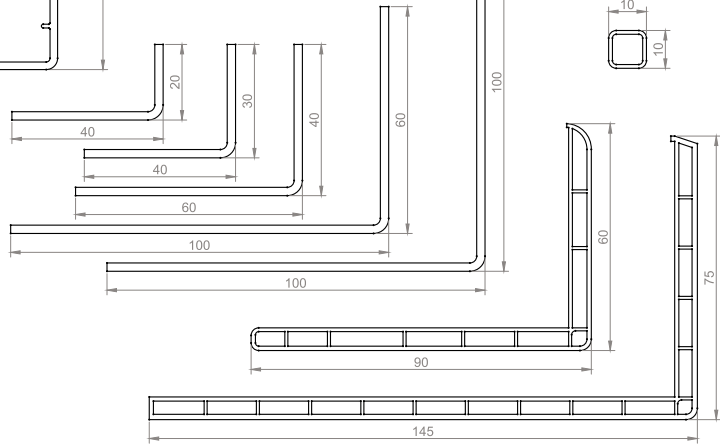
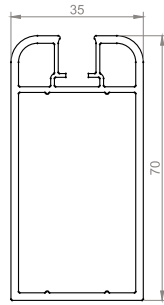
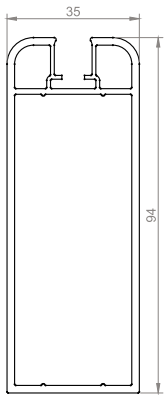
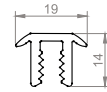
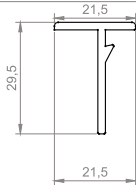
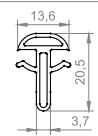
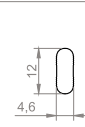
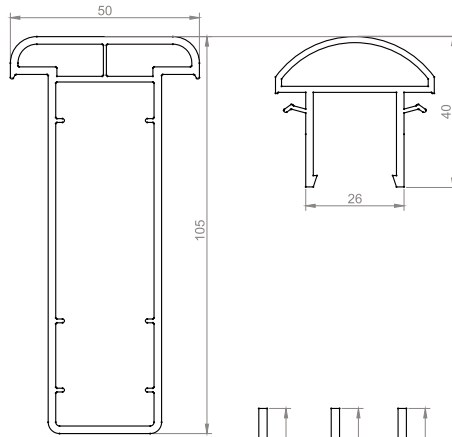
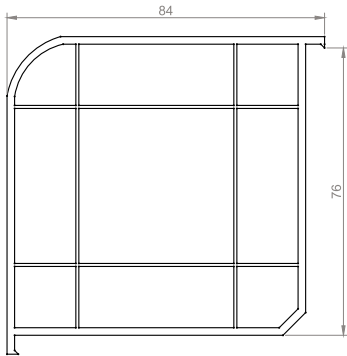
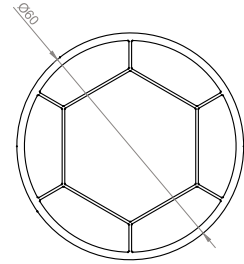
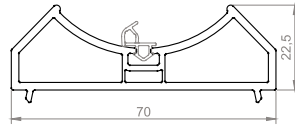
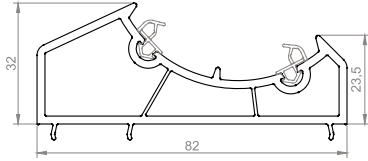

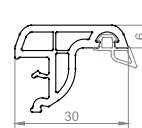
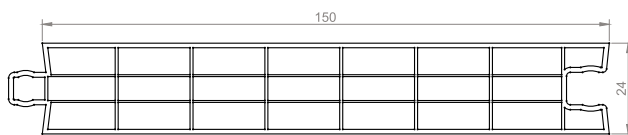
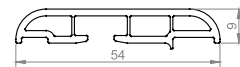
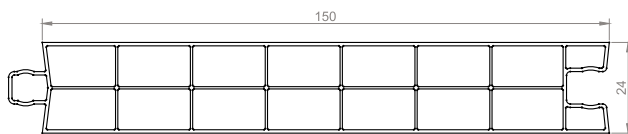
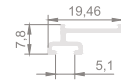
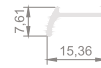
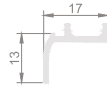
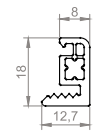
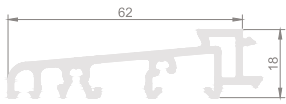
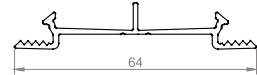
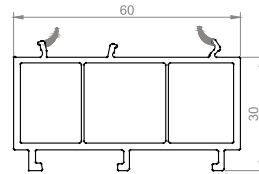
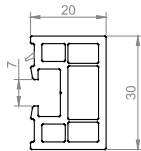
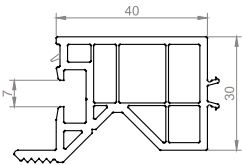
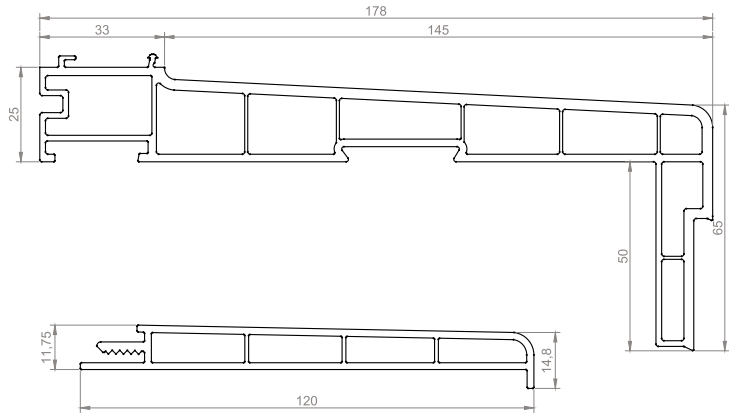
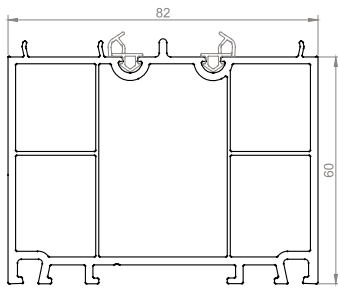

ECOLOGY CONCEPT



Pidosan, vizyonunda önemli başlıklarından birisi olan ekoloji bilinci ile ön plana çıkmaktadır. Pidosan, profillerinin sahip olduğu maksimum kullanım süresi, %100 geri dönüşüme tabi olma, ısı yalıtımı ve enerji tasarrufu özellikleri sayesinde müşterileriyle birlikte daha yeşil bir dünyada daha kaliteli bir yaşam için katkı sağlamayı amaçlamaktadır.

Ekolojik geleceğe önem veren en son teknolojisiyle birlikte üretim aşamalarında insana, geri dönüşüm sırasında ise doğaya büyük zararlar veren kurşun bazlı hammaddeler Pidosan ürünlerinde kullanılmamaktadır.

Bu maddelerin yerine doğaya zarar vermeyen kalsiyum-çinko hammaddeleri kullanılmaktadır. kalsiyum ve çinkodan üretilen bu yeni stabilizatör karışımının çevre dostu olmasının yanında diğer önemli özelliği ise her evrede pencerenin kalitesini artırmaktır.

KALSİYUM-ÇİNKO HAMMADESİ İLE ÜRETİLEN Pidosan PROFİLLERİNDEKİ ÖZELLİKLER ;

- ☒ Kötü hava koşullarına dayanıklılık; Laboratuvar testleri kalsiyum-çinko stabilizatörlerinden yapılan PVC profillerin diğerlerine göre kötü hava şartlarına daha dayanıklı olduğunu göstermiştir. En sert deneylerde bile dayanıklılığını korumuştur.
- ☒ Daha parlak; kalsiyum çinko stabilizatörlerinden yapılan PVC profiller her zaman daha parlak bir görüntüye sahiptir. Teknik ve optik olarak uzun süre parlaklığını koruyan bu profillerin kalitesi ilk bakışta da fark edilebilmektedir.
- ☒ Geri dönüşümü daha kolay; Gelecekte kurşun yok ! Kurşun yerine Kalsiyum-Çinko stabilizatörlerin kullanımı geri dönüşümü büyük oranda kolaylaştırmaktadır.

Pidosan stands out with its ecology awareness, which is one of the important topics in its vision. Pidosan aims to contribute to a better quality life in a greener world with its customers thanks to its profiles' maximum lifetime, 100% recycling, thermal insulation and energy saving features.

Lead-based raw materials, which give great harm to the human during the production stages and to the nature during recycling, with the latest technology that gives importance to the ecological future, are not used in Pidosan products.

Calcium-zinc raw materials that do not harm the nature are used instead of lead-based raw materials. Besides being environmentally friendly, this new stabilizer mixture made of calcium and zinc is to improve the quality of the window at every stage.

Pidosan PROFILES FEATURES PRODUCED OF CALCIUM - ZINC RAW

- ☒ Resistance to bad weather; Laboratory tests have shown that PVC profiles made of calcium-zinc stabilizers are more resistant to bad weather than others. It remained durable even in the harshest experiments.
- ☒ Brighter; PVC profiles made of calcium zinc stabilizers always have a brighter appearance. The quality of these profiles, which preserves their brightness technically and optically for a long time, can also be noticed at first glance.
- ☒ Recycling is easier; No lead in the future! The use of Calcium-Zinc stabilizers instead of lead greatly facilitates recycling.





Pidosan[®]

KAPI - PENCERE



Eski Yuva Yolu Üzeri Yuva Mah. 3702/1
Sokak No: 8/3 Yenimahalle ANKARA

www.pidosan.com
info@pidosan.com



Beğen!



Takip et!



Paylaş!